

GENERAL CHARACTERISTICS

The instruments are working according to the technology of a spring and bellow supported paddle. Electrical contact effected by a micro switch.

- * nominal diameter 25-100
- * hermetic separation of electrical and hydraulic components
- * protection of functional components from liquid by rubber bellow
- * easy adjustment of switch

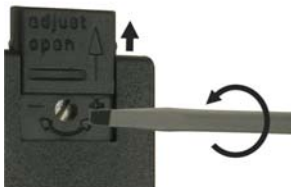

Male thread R1" brass/stainless steel



CM2K-025HM

TECHNICAL DATA

DN	PN bar	Qmax. recom. m ³ /h H ₂ O	adjustable range m ³ /h H ₂ O			
			paddle 1	paddle 1,2	paddle 1,2,3	paddle 1,2,3,4
25	25	3.6	0.9 - 1.0	-	-	-
32	25	6	2.3 - 2.7	-	-	-
40	25	9	2.8 - 3.4	-	-	-
50	25	15	6.5 - 7.5	1.9 - 2.4	-	-
65	25	24	11.4 - 13.3	4.8 - 5.7	-	-
80	25	36	16.5 - 18.9	7.6 - 8.9	2.7 - 3.5	-
100	25	60	26.3 - 30.3	13.3 - 15.3	6.7 - 8.4	5.4 - 6.7

Adjustable range is indicated for horizontally decreasing flow.

- | | |
|-----------------------|---|
| tolerance | ±15 % of full scale |
| media temperature | max. 110°C |
| average pressure loss | 0.15 bar at Qmax. |
| hysteresis | depending on switch value
minimum 5 l/min. |
| weight | 0.35kg |

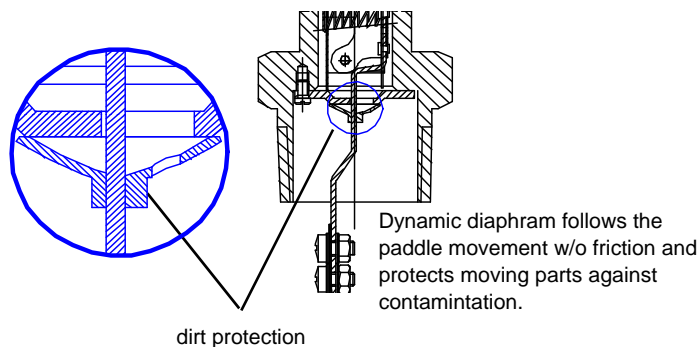

MATERIALS

	CM2K-025HM	CM2K-025HK
housing	brass Ms58 nickel plated	stainless steel 1.4571
paddle	stainless steel 1.4301 ; 1.4571	stainless steel 1.4301 ; 1.4571
bellow protection	NBR POM	NBR POM
spring	stainless steel 1.4310	stainless steel 1.4310
magnet	oxyd 300	oxyd 300

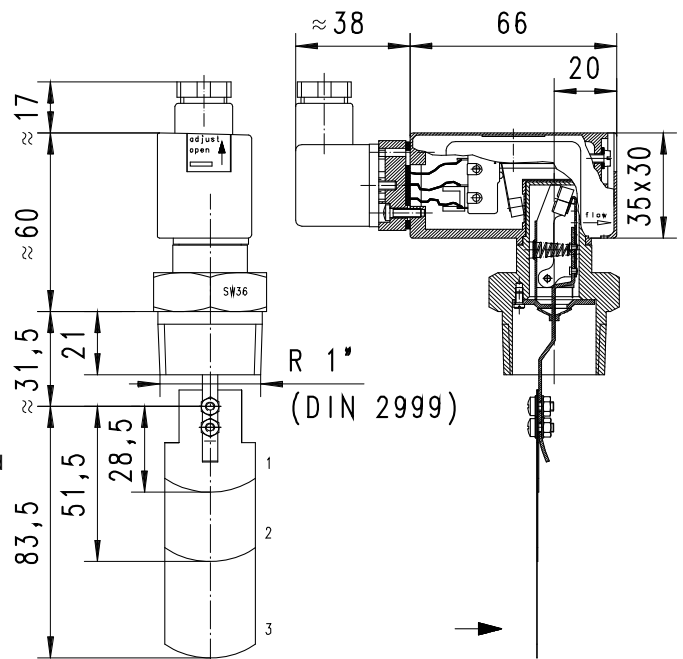

Attention! Paddle fixation not secured. With critical conditions (i.e. vibration) please protect paddle screws.

Paddel 1 to adjusted for DN25
Paddel 4 may be adjusted to pipe size
DN 100 paddle length 92

ELECTRICAL DATA

micro switch - wiring 0.371 change over
250 V AC 5 A
plug DIN 43650-A
protection class 2
protection class IP 65

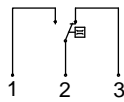

OBASIC
Programme options

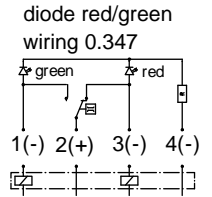
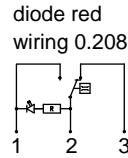
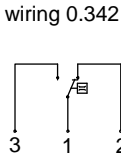

MOUNTING POSITION

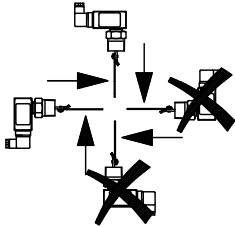

Installation position may influence switch value.

METERING SUBSTANCES

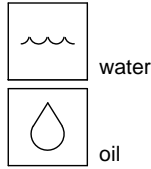

NOMENCLATURE

CM2K-	025	H	M	basic type specification
	025			● connection thread DN25 - R1"
		H		● socket thread
			M	● brass design
			K	● stainless steel design
Programme option BASIC				○ wiring 0.208 - diode red integrated in plug DIN 43650-A wiring 0.347 - diode red/green integrated in plug DIN 43650-A wiring 0.342 gold-plated micro switch 125 V AC / 30 V DC / 100mA
Special option VARIO				□ setting / adjustable ranges for oil contact for locking plug M12x1, 4-pole

IMPORTANT FOR YOUR ORDER

- Please indicate flow direction, metering substance and adjustable range with your order.
- With viscous liquids please indicate viscosity, temperature and metering substance (adjustable range on request)

All technical changes reserved

IBASIC Standard ○OBASIC Programme option □VARIO Special option ⊕ PLUS Accessories

X not recommendable