

**GENERAL CHARACTERISTICS**

Mechanical Flowmeter for liquids. A bellows-supported paddle activates a metering unit with a pointer range of 270°. Rugged design in brass or stainless steel.

Female thread G1/2 to G2 brass/stainless steel

- \* local metering
- \* low pressure loss
- \* good repeatability
- \* dirt-resistant
- \* easy adjustment by indicating pointer



**UZ-025GM100**

**TECHNICAL DATA**

	G	Type	Qmax. recom. l/min H <sub>2</sub> O	metering range l/min H <sub>2</sub> O ; 1bar abs		H mm	L mm	AF mm	X mm	weight kg
				flow from						
				left	right (optional)					
brass	G 1/2	UZ-015GM...	60	3 - 50		201	70	30	16	2.0
	G 3/4	UZ-020GM...	100	4 - 60		206	74	36	18	2.0
	G 1	UZ-025GM...	200	4 - 60	10 - 100	201	87	46	19	2.5
	G 1 1/4	UZ-032GM...	300	10 - 100	20 - 200	209	104	55	22	3.0
	G 1 1/2	UZ-040GM...	400	20 - 200	10 - 300	215	111	65	24	4.5
	G 2	UZ-050GM...	600	20 - 300	30 - 500	227	130	70	28	5.0
stainless steel	G 1/2	UZ-015GK...	60	3 - 50		201	70	30	16	2.0
	G 3/4	UZ-020GK...	100	4 - 60		206	74	36	18	2.0
	G 1	UZ-025GK...	200	4 - 60	10 - 100	201	87	46	19	2.5
	G 1 1/4	UZ-032GK...	300	10 - 100	20 - 200	209	104	55	22	3.0
	G 1 1/2	UZ-040GK...	400	20 - 200	10 - 300	215	111	65	24	4.5
	G 2	UZ-050GK...	600	20 - 300	30 - 500	227	130	70	28	5.0

Metering range is indicated for horizontally increasing flow.  
Please notice the pressure-dependent deviation of the indication range.

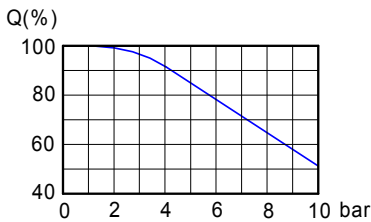

- tolerance ±3% of full scale
- pressure range 16 bar static  
6 bar dynamic
- media temperature max. 100°C
- average pressure loss 0.2 bar at Qmax.

**MATERIALS**

	<b>UZ-...GM</b>	<b>UZ-...GK</b>
housing	brass Ms58 nickel plated	stainless steel 1.4305
paddle	stainless steel 1.4571 ; 1.4305	stainless steel 1.4571 ; 1.4305
bellows	stainless steel 1.4571	stainless steel 1.4571

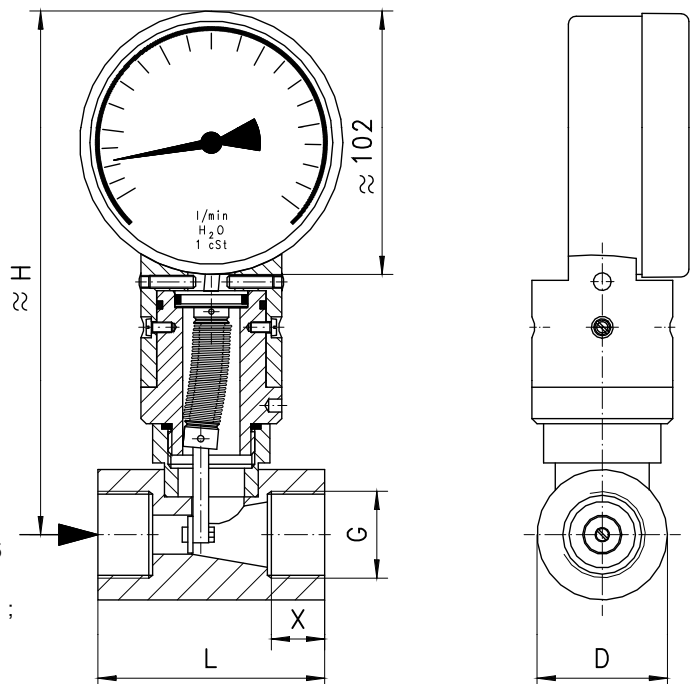

**ELECTRICAL DATA**

● **BASIC Standard**

No electrical components.

○ **BASIC Programme option**

integrated micro switch  
with front switch units  
see next page.

**MOUNTING POSITION**

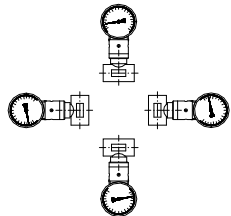

Installation position may influence metering range.

**METERING SUBSTANCES**

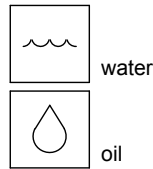

water

oil

**NOMENCLATURE**

For combinations see table "technical data".

UZ-	015	G	M	035	basic type specification	
UZ-					●	Flowmeter
UZM-					○	Flowmeter with integrated micro switch
	015				●	nominal □ dia DN 15 - G1/2 DN 20 - G3/4 DN 25 - G1 DN 32 - G1 1/4 DN 40 - G1 1/2 DN 50 - G2
	020				●	
	025				●	
	032				●	
	040				●	
	050				●	
		G			●	
			M		●	brass design
			K		●	stainless steel design
				035	○	metering range H <sub>2</sub> O horizontal 35 l/min of full scale 45 l/min of full scale 50 l/min of full scale 60 l/min of full scale 70 l/min of full scale 100 l/min of full scale 200 l/min of full scale 300 l/min of full scale 500 l/min of full scale
				045	○	
				050	●	
				060	●	
				070	○	
				100	●	
				200	●	
				300	●	
				500	●	
Programme option					○	front switch unit with 10-kOhm-potentiometer
BASIC						
Special option					□	metering range for oil or gas
VARIO						front switch unit 2pol, n.o. or n.c. flange design

**IMPORTANT FOR YOUR ORDER**

- Please indicate flow direction, metering substance and metering range with your order  
With pressure >1 bars abs please require metering range.
- With viscous liquids please indicate viscosity, temperature and metering substance, e.g. ISO VG 68 (metering range on request)

All technical changes reserved

●BASIC Standard ○BASIC Programme option □VARIO Special option ⊕ PLUS Accessories

✗ not recommendable

**OPTION**

**UZM-** integrated micro switch

wiring 0.342 change over  
250 V AC 5 A  
plug DIN 43650-A  
protection class IP 65

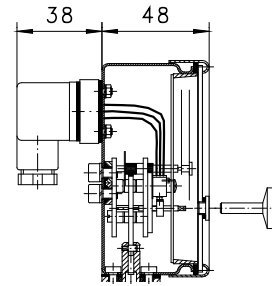
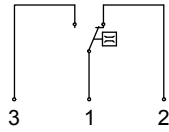

**UZP-** front switch unit with 10-kOhm- potentiometer

wiring 0.269  
50 V DC 100 mA 1.5 W  
resistance max. 10 kΩ  
additional tolerance ±3 %  
resistance tolerance ±1 %  
linearity ±0.3 %  
plug Hirschmann G4  
protection class IP 60

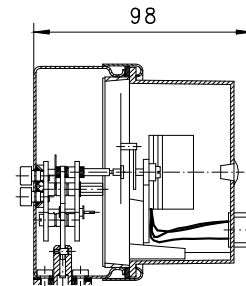
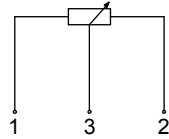

**UZM2-** switch unit with 2pole n.o.

wiring 0.268  
250 V AC 0.6 A 50 VA  
plug Hirschmann G4  
protection class IP 60

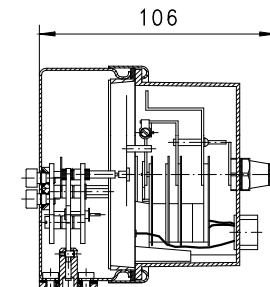
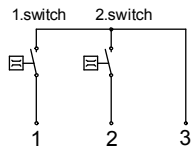

**UZM3-** switch unit with 2pole n.c.

wiring 0.285  
250 V AC 0.6 A 50 VA  
plug Hirschmann G4  
protection class IP 60

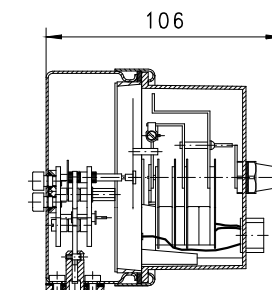
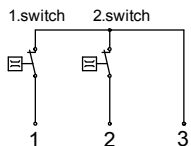

All technical changes reserved

●BASIC Standard ○BASIC Programme option □VARIO Special option ⊕ PLUS Accessories ✗ not recommendable