

GENERAL CHARACTERISTICS

The Temperature Transmitter consists of a PT100 resistance sensor with very good dynamic behavior due to the small diameter of the measurement probe. The change in resistance generated by temperature is converted to a 4..20 mA signal proportional to temperature by the linearised electronic. As the sensor is supplied with < 4 mA a double wire connection could be realised. At the same time this type of sensor can be employed as an open circuit monitor.

The temperature probe is welded to the threaded housing. Because the whole upper housing can be rotated, you can orientate your cable connection in any position subsequent to final assembly.

- * 4..20 mA double wire transmitter
- * small probe dimensions
- * fast response time
- * rotating plug connection (infinitely variable)

male thread G1/2A stainless steel



TECHNICAL DATA

range	0..100°C
option	temperature <0°C
accuracy	1% FS
dynamics (τ)	5 s
operating pressure	max. 25 bar
operating temperature	max. 80°C (with "goose-neck" max. 250°C)
operating temperature of the electronic	0..80°C
weight	0.2kg

with connection at locking plugs M12x1, 4pole

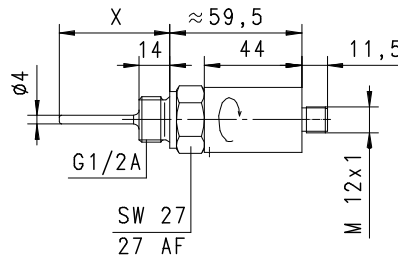

with plug DIN 43650-A

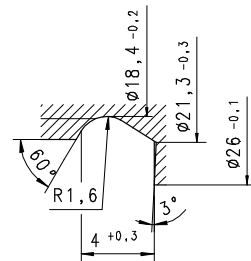
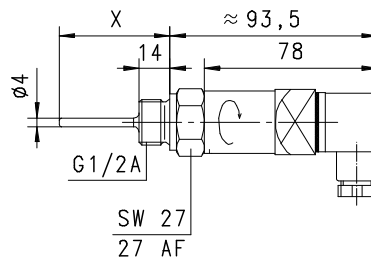

recess
DIN 3852 Bl.2

"goose-neck" option for higher temperatures

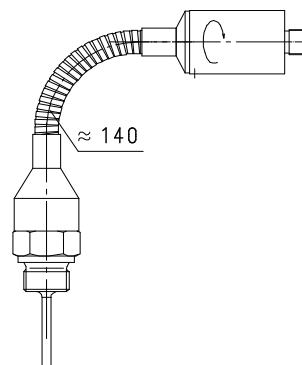

MOUNTING

The sensors are installed with appropriate sealing (Teflon tape or triplex etc.) in a connection piece or a T-piece of the pipe. To tighten the sensor please use only the hexagonal key provided (AF27mm). The tip of the probe should be completely surrounded by the medium when in use. Please avoid installing in high temperature sites where the sensor housing is exposed to the convected heat of the pipe.

After sealing, you can turn the sensor into the correct cable input position. An over turn security limits the turn range to nearly 360°.

MATERIALS

temperature probe stainless steel 1.4571
other materials brass nickel plated, PP

ELECTRICAL DATA

supply voltage	10..30 V DC ±10%
analogue output	4..20 mA
max. load	700W at 24 V (100W at 10V - 1K at 30V, linear to the operation voltage)
connection	for locking plug M12x1, 4pole or plug DIN 43650-A
protection class	IP 67 locking plug IP 65 plug DIN 43650-A

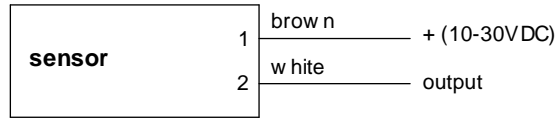

Before carrying out the electrical installation, make sure that the supply voltage corresponds to the data specification.

MOUNTING POSITION

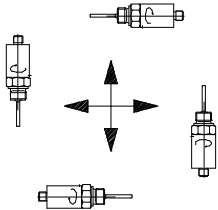

METERING SUBSTANCES

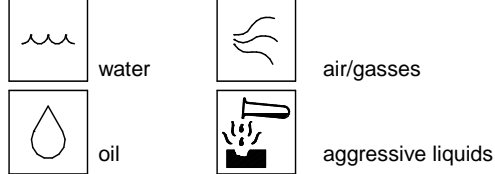

NOMENCLATURE

ETS-	100	K	015	B	050		basic type specification
	100						● range 0 - 100 °C
	250						○ range 0 - 250°C only with "goose-neck"
		K					● probe stainless steel 1.4571
			015				● connection G1/2A
				S			● connection at locking plugs M12x1, 4-pole
				B			● plug DIN 43650-A
					050		● probe length 50 mm
					100		● probe length 100 mm
					150		● probe length 150 mm
					200		● probe length 200 mm
						H	○ with goose-neck

ACCESSORY

Locking plug M12x1

K	PU-	02	S	G	basic type specification
K					● ready-made cable
KB04					● self makable cable 4-pole
	PU-				● material PUR
		02			● length 2 m
		05			● length 5 m
		10			● length 10 m
			S		● moulded-on plug
				G	● straight plug
				W	● angled plug 90°



COMBINATIONS

omni-T

local electronic unit,
2xNPN and PNP switch
4(0)..20mA output
graphical LCD display
with flashing LED
program ring



Flex-T

switch- or frequency output
0..10V or 4..20mA
PNP, NPN

All technical changes reserved

●BASIC Standard ○BASIC Programme option □VARIO Special option ⊕ PLUS Accessories ✗ not recommendable